

Houston Ball 2022

1 GOOD HEARTED GLASGOW J32 · 3/4L

Peter Knapman: A Guide to Scottish Country Dancing (ex-Collins) · Crib: MiniCribbs · Diagram: Keith Rose's Diagrams

- 1-8 1s turn RH & cast to 2nd place, turn partner LH 1.1/4 times
- 9-16 1s dance RH across (Lady with 2s at top & Man with 3s); 1s pass RSh & dance LH across with other couple
- 17-24 1s lead down the middle & back to 2nd place own side
- 25-32 2s+1s+3s circle 6H round & back

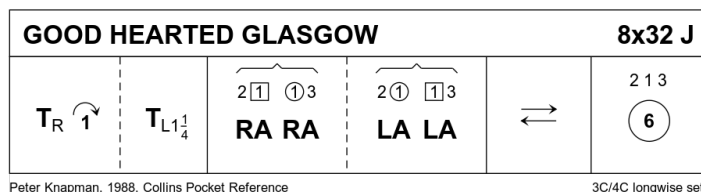

2 ARKANSAS TRAVELER R32 · 3/4L

John Roby · Crib: MiniCribbs · Diagram: Keith Rose's Diagrams

- 1-8 1s 1/2 turning 2s on sides (Men RH, Ladies LH) & dance Double Triangles, 1s end facing out on opposite sides retaining hands with 2s
- 9-16 1s turn 2s, dance down to 3s, joining hands set in line & turn 3s into...
- 17-24 1s dance reflection reels of 3 on opposite sides (dancing between 2s to start)
- 25-32 1s dance 1/2 Fig of 8 round 2s to 2nd place own sides & 2s+1s+3s turn partners RH

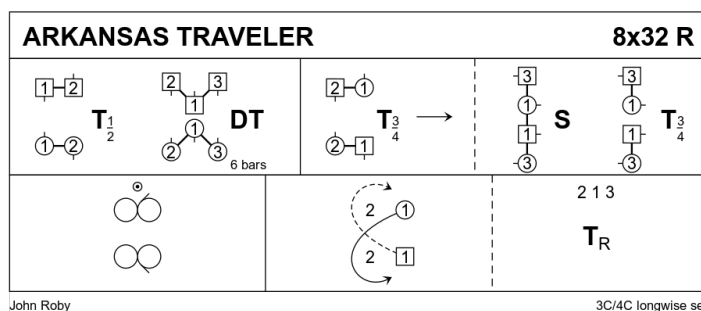

3 O'ER THE MOUNTAINS S32 · 3/4L

Paula Carnes · Crib: MiniCribbs

- 1-8 1s turn 2H, 1s+2s+3s dance mirror reels of 3 on sides (1s in/down to start)
- 9-16 1s dance in & cast (2s step up 11-12); 1s dance 1/2 Fig 8 (1M round 3s, LSh to 3L, 1L round 2s, LSh to 2M). 1s join LH with partner in centre & RH with 2nd corners
- 17-24 1s+2nd corners "Strathspey Balance & Turn":
 - 17 1s drop LH, 1s+2nd corners set to right, release RH & join LH
 - 18 1s+2nd corners 1/2 turn LH & briefly join RH with partner
 - 19-20 1s drop LH, join RH with partner & set to right, 1s 1/2 turn LH **while** 2nd corners set
 - 21-24 1s turn 2nd corners RH, turn partner 3/4 LH to join RH with 1st corners
- 25-32 1s repeat 17-24 with 1st corners. 1s end in 2nd place own side. 2 1 3

4 THE MONTGOMERIES' RANT R32 · 3/4L

Castle Menzies (18C): RSCDS X 1 · Crib: MiniCribs · Diagram: Keith Rose's Diagrams

- 1-8** 1s cross RH & cast down to 2nd place (2s step up), cross LH & 1L casts up **while** 1M casts down
- 9-16** 1s dance reels of 3 across, 1L with 2s (RSh to 2M) & 1M with 3s (RSh to 3L)
- 17-24** 1s NHJ (Lady on Mans left) set to 2L & turn inwards to set to 3M, set to 3L & turn inward & set to 2M. End facing own 2nd corner (1L pull back LSh to face down)
- 25-32** 2s+1s+3s dance reels of 3 on opposite sides 1s giving RSh to 2nd corner, 1s cross RH to 2nd place own sides

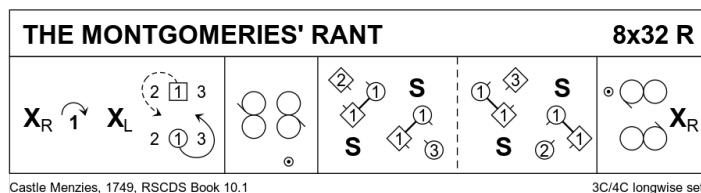

5 THE LAMMERMUIR HILLS S32 · 2/4L

Roy Goldring: Auld Friends Meet · Crib: MiniCribs · Diagram: Keith Rose's Diagrams

- 1-8** 1s+2s dance Diamond Poussette
- 9-16** 1L+2M cross RH & cast behind partners back to original places, 1s+2s dance RH across
- 17-24** 1M+2L cross LH & cast behind partners back to original places, 1s+2s dance LH across
- 25-32** 1s+2s dance the Knot

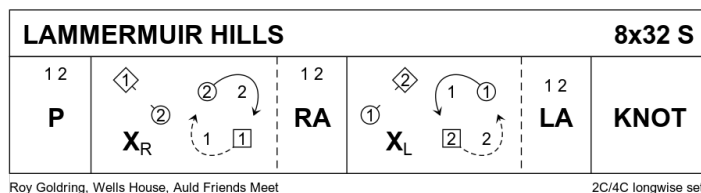

6 THE ROTHESAY RANT J32 · 4S

Anna Campbell Holden: Collins Pocket Reference: Scottish Country Dancing · Crib: MiniCribs · Diagram: Keith Rose's Diagrams

- 1-8** All 1/2 turn partners RH, retain hold & give LH to next person & all set (M facing out), 1/2 turn next person LH & all set end Ladies turning inwards
- 9-16** 1s+3s (in 2nd & 4th places) dance 1/2 Ladies' Chain & 1/2 R&L
- 17-24** 2s+4s dance 1/2 Ladies' Chain & 1/2 R&L
- 25-32** All circle 8H round & back

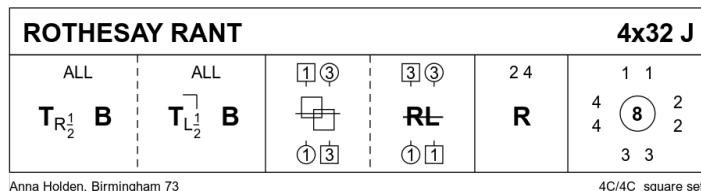

7 STEP PRACTICE – Intermission

8 A CAPITAL JIG J32 · 3/4L

Tine E MacKay: Magazine Dances 2005-2009 · Crib: MiniCribbs · Diagram: Keith Rose's Diagrams

- 1-8** 1s+2s Set & Rotate & end 1s facing up, 2s down:
Set, rotate singly & dance on 1 place clockwise, change places RH on sides & dance on 1 place to own sides (1s in 2nd place facing up)
- 9-16** 1s dance reels of 3 on own sides (RSh to 2s)
- 17-24** 1s set & turn 3/4 RH to face own sides, 1s dance LH across (1L with 2s, 1M with 3s) to end 2nd place opposite sides
- 25-32** 1s set & turn 3/4 RH to face opposite sides, 1s dance LH across (1M with 2s, 1L with 3s) ending 2nd place own sides

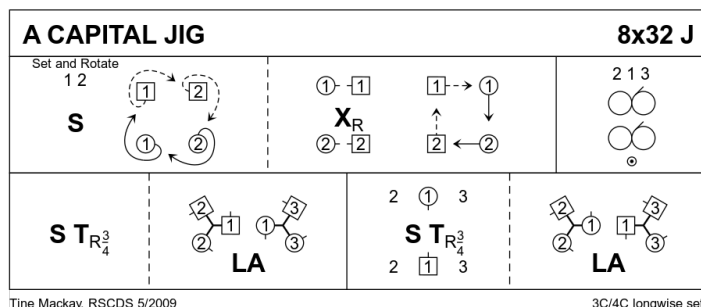

9 THE ROYAL DEESIDE RAILWAY R32 · 3/4L

Ron Arrowsmith: RSCDS XL 9 · Crib: MiniCribbs · Diagram: Keith Rose's Diagrams

- 1-8** 1s cross down (no hands) below 3s, cast up 1 place opposite sides & dance in to face 2L, 1s+2L dance RH across
- 9-16** 1s+2M dance LH across & end 1L (with partner behind her) in centre facing up, 1s dance up & cast 1 place on own sides & face 3M
- 17-24** 1s+3M dance RH across, 1s+3L dance LH across & end 1L (with partner behind her) in centre facing down
- 25-32** 1s dance down below 3s & cast up on own sides to 2nd place, 2s+1s+3s turn RH

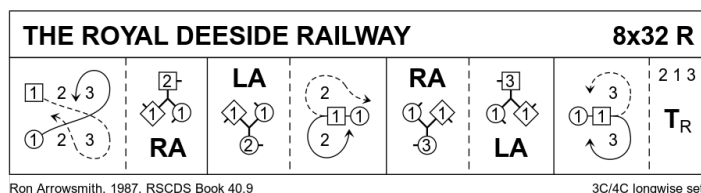

10 BOB CAMPBELL S32 · 3/4L

John Drewry: The Canadian Book of Scottish Country Dances · Crib: MiniCribbs · Diagram: Keith Rose's Diagrams

- 1-8** 1s+2s+3s set, turn 2H to end 1s facing down & 2s+3s facing up in centre, 1s+2s set advancing passing LSh to change places **while** 3s set, 2s turn 2H **while** 1s+3s set advancing to change places
- 9-16** 2s+3s set advancing to change places **while** 1s turn 2H, 3s turn 2H **while** 2s+1s set advancing to change places & repeat to 1 2 3
- 17-24** 1s+2s dance the Rondel ending with 1s crossing to opposite sides
- 25-32** 1L+3M turn LH **while** 1M+3L turn RH, 2M+1L 1/2 turn RH **while** 2L+1M 1/2 turn LH, 1s cross down to 2nd place as 2s dance out & up to 1st place

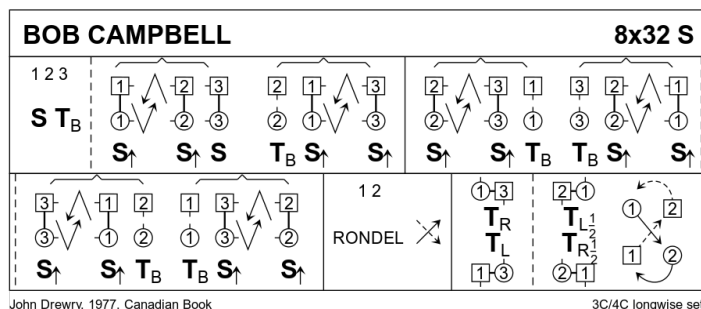

11 TRIP TO TIMBER RIDGE R32 · 3/4L

Linda Henderson: RSCDS LII 12 · Crib: MiniCrib · Diagram: Keith Rose's Diagrams

- 1-8** 1s turn RH, cast (2s step up) then 1L+2s & 1M+3s dance RH across. 1s end facing 1st corners
- 9-16** 1s dance Corner Pass+Turn with 1st corners, pass RSh & repeat with 2nd corners. 1s pull back RSh to end BtoB in centre facing opp sides
- 17-24** 2s+1s+3s dance Double Triangles. Bars 23-24 1s petronella turn to 2nd place own sides
- 25-32** 2s+1s+3s circle 6H round and back

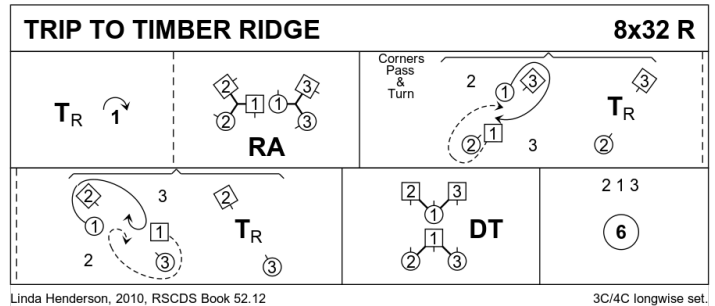

12 JEAN MARTIN OF ABERDEEN S32 · 3/3L

Muriel A Johnstone: Magazine Dances 2005-2009 · Crib: MiniCrib · Diagram: Keith Rose's Diagrams

- 1-8** 1s turn RH & cast 1 pl, all circle 6H round 3/4 way to left & end in lines of 3 across (Ladies face down & Men up)
- 9-16** All set & change places with partner RH, all circle 6H round 3/4 way to left & end in middle facing up. 3 1 2
- 17-24** All dance Allemande. 2 1 3
- 25-32** 1s+3s (bottom 2 couples) dance the Bourrel to end 2 3 1 :
1M+3L set advg, 3/4 turn 2H & twirl to end BtoB (up/down middle L facing up & M down) **while** 1L+3M chase anticl'wise 1/2 way to face ptrnr
1s+3s set to partners & turn 2H to own sides having changed places

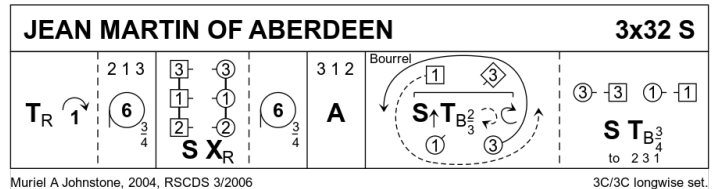

13 POSTIE'S JIG J32 · 4/4L

Roy Clowes: Thirty Popular Dances, Volume Two · Crib: MiniCrib · Diagram: Keith Rose's Diagrams

- 1-8** 1s & 4s set & cast in 1 place, 1s & 4s dance 1/2 Figs of 8 round new end couples
- 9-12** 1M+4M & 1L+4L cross (men making an arch) & turn corners with free hand to face up/down
- 13-16** 1s+4s dance down/up (couple dancing up make the arch) & turn corners
- 17-24** Repeat bars 9-16 from new positions
- 25-32** 1s+4s dance 1/2 R&L, turn partner RH

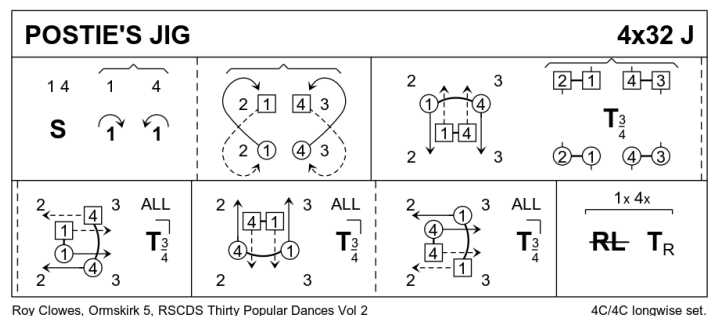

14 STEP PRACTICE – Intermission

15 THE LAIRD OF MILTON'S DAUGHTER J32 · 3/4L

Craigmyle: RSCDS XXII 10 · Crib: MiniCribs · Diagram: Keith Rose's Diagrams

- 1-8** 1s set, cross RH, cast 1 place & turn LH to face 1st corners
- 9-24** 1s dance Corner Chain with 1st & 2nd corners :
1s change pl RH with 1st crnrs, 1st crnrs turn LH in centre & return to places giving RH to 1s who turn LH in centre to face 2nd crnrs
1s change places RH with 2nd crnrs, 2nd crnrs turn LH in centre & return to places giving RH to 1s & 1s end with a 1/2 turn LH to 2nd place own sides
- 25-32** 2s+1s+3s circle 6H round & back

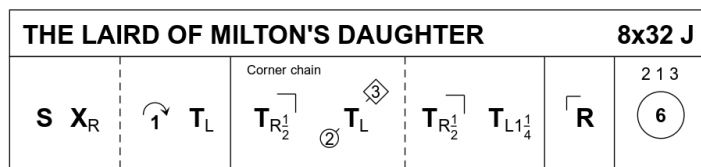

Lord Craigmyle, RSCDS Book 22.10

3C/4C longwise set.

16 JOHN MCALPIN S32 · 3/4L

Hugh Foss: Magazine Dances 2005-2009 · Crib: MiniCribs · Diagram: Keith Rose's Diagrams

- 1-8** 1s Adv+Ret 1 step (touch RH) & cross LH, lead down RH 1 place & 3/4 turn LH to face 1st corners
- 9-16** 1s turn RH 1st corner & turn partner LH, turn RH 2nd corner then cross LH to 2nd place own sides
- 17-24** 2L+1L+3L set, Adv+Ret & set **while** 2M+1M+3M stand for 2 bars, set, Adv+Ret
- 25-32** 2s+1s+3s cross RH, circle 6H round to left 1/2 way, cross LH & circle 6H round to right 1/2 way

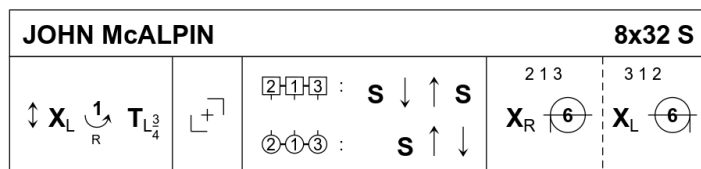

Hugh Foss, Galloway Album, RSCDS 3 Foss, Magazine 2005-2009

3C/4C longwise set.

17 THE DUKE AND DUCHESS OF EDINBURGH R40 · 3/4L

Allie Anderson & Florence D. Lesslie: RSCDS XXXIX 7 · Crib: MiniCribs · Diagram: Keith Rose's Diagrams

- 1-8** 1s+2s+3s Adv+Ret & turn partners 2H
- 9-16** 1s cast, lead down between 3s, cast up behind 3s, lead up between 2s & cast back to 2nd place
- 17-24** 1s dance RH across (Lady with 2s & Man with 3s), pass RSh & dance LH across with other couple to end facing 1st corners
- 25-32** 1s turn 1st corner, partner, 2nd corner & partner to own sides 2nd place
- 33-40** 2s+1s+3s circle 6H round & back

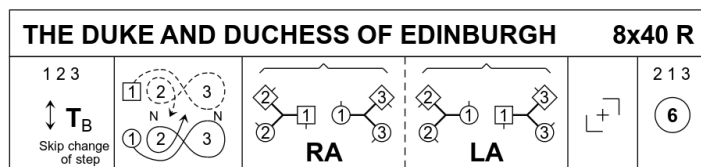

Allie Anderson & Florence Lesslie, 1947, RSCDS Book 39.7

3C/4C longwise set.

18 PELORUS JACK J32 · 3/4L

Barry Skelton: RSCDS XLI 1 · Crib: MiniCrib · Diagram: Keith Rose's Diagrams

- 1-8** 1s cross RH & cast 1 place (2s step up 3-4), 1s dance RH across with 3s. 1s end with Man facing his 1st corner with his partner behind him
- 9-16** 1s dance Alternating Tandem 1/2 reel of 3 with 1st corners to face Man's 2nd corner, 1s dance Alternating Tandem 1/2 reel of 3 with 2nd corners
- 17-24** 1s dance Alternating Tandem 1/2 reels of 3 with Ladies' 1st corner (pstn), 1s dance Alternating Tandem 1/2 reel with Ladies' 2nd corner (pstn)
- 25-32** 1M followed by partner dance into LH across with 2s, 1s retain LH & 1/2 turn to own sides & 2s+1s+3s set

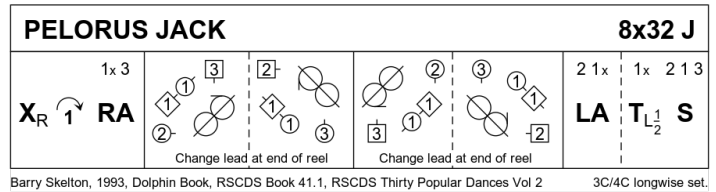

19 SEA TANGLE OF SKYE S32 · 2/4L

Liz Donaldson: Dances of an Island Clan · Crib: MiniCrib · Diagram: Keith Rose's Diagrams

- 1-8** 1s lead down, 1/2 turn RH, lead up & 1/2 turn RH
- 9-16** 1s+2s dance RH across, dance LH across for 2 bars & 2M+1M also 2L+1L 1/2 turn LH on sides
- 17-24** 1s+2s set, turn partner 2H; 1s+2s circle 4H round to left
- 25-32** 1s+2s face in diagonally, Petronella turn 1 place to right & dance RH across 1/2 way; Petronella turn to right 1 place & dance 1/2 LH across. 2 1

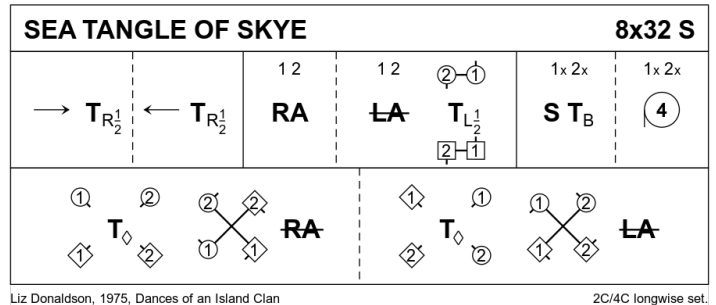

20 THE REEL OF THE ROYAL SCOTS R32 · 3/4L

Roy Goldring: The Leaflet Dances with Music · Crib: MiniCrib · Diagram: Keith Rose's Diagrams

- 1-8** 1s 1/2 turn 2s on sides (1M RH - 1L LH) to face out, 2s+1s+3s set, 1s 1/2 turn 3s on sides (1M LH - 1L RH) end 3s facing out & 2s+3s+1s set
- 9-16** 1s followed by 3s dance up between 2s, cast down 1 place, dance in & 1s cast up to 2nd place 3s end in 3rd place
- 17-24** 1s turn 1st corners RH, pass partner RSh turn 2nd corners RH & cross passing partner RSh to 2nd place own sides
- 25-32** 2s+1s+3s circle 6H round & back

